

Branching modules/Distributor blocks MS-FRM, MS series

FESTO



Festo core product range
Covers 80% of your automation tasks

Worldwide:

Always in stock

Superb:

Festo quality at an attractive price

Easy:

Reduces procurement and storing complexity

★ Ready for dispatch from the Festo factory in 24 hours
Held in stock in 13 service centres worldwide
More than 2200 products



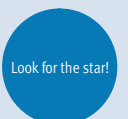



★ Ready for dispatch in 5 days maximum from stock
Assembled for you in 4 service centres worldwide
Up to 6 x 10¹² variants per product series

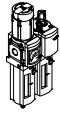
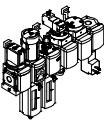

Branching modules/Distributor blocks MS-FRM, MS series

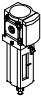

Product range overview – MS series service units

Type	Size	Pneumatic connection in housing	Connecting plate	Pressure regulation range [bar]						Grade of filtration [µm]			
				0.05 ... 0.7	0.05 ... 2.5	0.1 ... 4	0.3 ... 7	0.1 ... 12	0.5 ... 16	0.01	1	5	40
Code			AG.../AQ...	D2	D4	D5	D6	D7	D8	A	B	C	E
Service unit combinations													
MSB-FRC 	4	G1/8, G1/4	G1/8, G1/4, G3/8	-	-	-	■	■	-	-	-	■	■
	6	G1/4, G3/8, G1/2	G1/4, G3/8, G1/2, G3/4	-	-	-	■	■	-	-	-	■	■
	9	-	-	-	-	-	-	-	-	-	-	-	-
	12	-	-	-	-	-	-	-	-	-	-	-	-
Service unit combinations (further variants can be ordered using the configurator → Internet: msb4, msb6 or msb9)													
MSB 	4	G1/4	G1/8, G1/4, G3/8	-	-	-	■	■	-	-	-	■	■
	6	G1/2	G1/4, G3/8, G1/2, G3/4	-	-	-	■	■	-	-	-	■	■
	9	-	-	-	-	-	-	-	-	-	-	-	-
	12	-	-	-	-	-	-	-	-	-	-	-	-
Individual devices													
Filter regulators MS-LFR 	4	G1/8, G1/4	G1/8, G1/4, G3/8	-	-	■	■	■	-	-	-	■	■
	6	G1/4, G3/8, G1/2	G1/4, G3/8, G1/2, G3/4	-	-	■	■	■	■	-	-	■	■
	9	G3/4, G1	G1/2, G3/4, G1, G1 1/4, G1 1/2	-	-	■	■	■	■	-	-	■	■
	12	-	G1, G1 1/4, G1 1/2, G2	-	-	-	■	■	■	-	-	■	■
Filters MS-LF 	4	G1/8, G1/4	G1/8, G1/4, G3/8	-	-	-	-	-	-	-	-	■	■
	6	G1/4, G3/8, G1/2	G1/4, G3/8, G1/2, G3/4	-	-	-	-	-	-	-	-	■	■
	9	G3/4, G1	G1/2, G3/4, G1, G1 1/4, G1 1/2	-	-	-	-	-	-	-	-	■	■
	12	-	G1, G1 1/4, G1 1/2, G2	-	-	-	-	-	-	-	-	■	■
Fine and micro filters MS-LFM 	4	G1/8, G1/4	G1/8, G1/4, G3/8	-	-	-	-	-	-	■	■	-	-
	6	G1/4, G3/8, G1/2	G1/4, G3/8, G1/2, G3/4	-	-	-	-	-	-	■	■	-	-
	9	G3/4, G1	G1/2, G3/4, G1, G1 1/4, G1 1/2	-	-	-	-	-	-	■	■	-	-
	12	-	G1, G1 1/4, G1 1/2, G2	-	-	-	-	-	-	■	■	-	-
Activated carbon filters MS-LFX 	4	G1/8, G1/4	G1/8, G1/4, G3/8	-	-	-	-	-	-	-	-	-	-
	6	G1/4, G3/8, G1/2	G1/4, G3/8, G1/2, G3/4	-	-	-	-	-	-	-	-	-	-
	9	G3/4, G1	G1/2, G3/4, G1, G1 1/4, G1 1/2	-	-	-	-	-	-	-	-	-	-
	12	-	G1, G1 1/4, G1 1/2, G2	-	-	-	-	-	-	-	-	-	-
Water separators MS-LWS 	4	-	-	-	-	-	-	-	-	-	-	-	-
	6	G1/4, G3/8, G1/2	G1/4, G3/8, G1/2, G3/4	-	-	-	-	-	-	-	-	-	-
	9	G3/4, G1	G1/2, G3/4, G1, G1 1/4, G1 1/2	-	-	-	-	-	-	-	-	-	-
	12	-	G1, G1 1/4, G1 1/2, G2	-	-	-	-	-	-	-	-	-	-

Branching modules/Distributor blocks MS-FRM, MS series



Product range overview – MS series service units

Type	Size	Bowl guard		Condensate drains				Pressure indicator					Security		Options		→ Page/ Internet
		Plastic bowl with plastic bowl guard	Metal bowl	Manual rotary	Semi-automatic	Fully automatic	External, fully automatic, electrical	Cover plate (without pressure gauge)	Integrated MS pressure gauge	Adapter plate for EN pressure gauge G1/8	Adapter plate for EN pressure gauge G1/4	Pressure sensor	Rotary knob with detent, lockable via accessories	Rotary knob with integrated lock	Silencer	Flow direction from right to left	
Code		R	U	M	H	V	E...	VS	AG	A8	A4	AD...	AS	E11	S	Z	
Service unit combinations																	
MSB-FRC	4	■	-	■	-	■	-	-	■	-	-	-	■	-	-	■	msb4
	6	■	■	■	-	■	-	-	■	-	-	-	■	-	-	■	msb6
	9	-	-	-	-	-	-	-	-	-	-	-	-	-	-	-	-
	12	-	-	-	-	-	-	-	-	-	-	-	-	-	-	-	-
Service unit combinations																	
MSB	4	■	■	■	-	■	-	-	■	-	-	-	■	-	-	■	msb4
	6	■	■	■	-	■	-	-	■	-	-	-	■	-	-	■	msb6
	9	-	-	-	-	-	-	-	-	-	-	-	-	-	-	-	-
	12	-	-	-	-	-	-	-	-	-	-	-	-	-	-	-	-
Individual devices																	
Filter regulators MS-LFR	4	■	■	■	■	■	-	■	■	■	■	■	■	■	-	■	ms4-lfr
	6	■	■	■	■	■	■	■	■	■	■	■	■	■	-	■	ms6-lfr
	9	-	■	■	■	■	■	■	■	■	■	■	■	■	-	■	ms9-lfr
	12	-	■	■	-	■	■	■	■	■	■	■	■	■	-	■	ms12-lfr
Filters MS-LF	4	■	■	■	■	■	-	-	-	-	-	-	-	-	-	■	ms4-lf
	6	■	■	■	■	■	■	-	-	-	-	-	-	-	-	■	ms6-lf
	9	-	■	■	■	■	■	-	-	-	-	-	-	-	-	■	ms9-lf
	12	-	■	■	-	■	■	-	-	-	-	-	-	-	-	■	ms12-lf
Fine and micro filters MS-LFM	4	■	■	■	■	■	-	-	-	-	-	-	-	-	-	■	ms4-lfm
	6	■	■	■	■	■	■	-	-	-	-	-	-	-	-	■	ms6-lfm
	9	-	■	■	■	■	■	-	-	-	-	-	-	-	-	■	ms9-lfm
	12	-	■	■	-	■	■	-	-	-	-	-	-	-	-	■	ms12-lfm
Activated carbon filters MS-LFX	4	■	■	-	-	-	-	-	-	-	-	-	-	-	-	■	ms4-lfx
	6	■	■	-	-	-	-	-	-	-	-	-	-	-	-	■	ms6-lfx
	9	-	■	-	-	-	-	-	-	-	-	-	-	-	-	■	ms9-lfx
	12	-	■	-	-	-	-	-	-	-	-	-	-	-	-	■	ms12-lfx
Water separators MS-LWS	4	-	-	-	-	-	-	-	-	-	-	-	-	-	-	-	-
	6	-	■	-	-	■	■	-	-	-	-	-	-	-	-	■	ms6-lws
	9	-	■	-	-	■	■	-	-	-	-	-	-	-	-	■	ms9-lws
	12	-	■	-	-	■	■	-	-	-	-	-	-	-	-	■	ms12-lws

Branching modules/Distributor blocks MS-FRM, MS series



Product range overview – MS series service units

Type	Size	Pneumatic connection in housing	Connecting plate	Pressure regulation range [bar]								Supply voltage			
				0.05	0.05	0.1	0.3	0.1	0.5	24 V DC, connection pattern to EN 175301	24 V DC, connection M12 to IEC 61076-2-101	110 V AC, connection pattern to EN 175301	230 V AC, connection pattern to EN 175301		
Code			AG.../AQ...	D2	D4	D5	D6	D7	D8	V24	V24P	V110	V230		
Individual devices															
Pressure regulators MS-LR		4	G1/8, G1/4	G1/8, G1/4, G3/8	-	-	■	■	■	-	-	-	-		
		6	G1/4, G3/8, G1/2	G1/4, G3/8, G1/2, G3/4	-	-	■	■	■	■	-	-	-		
		9	G3/4, G1	G1/2, G3/4, G1, G1 1/4, G1 1/2	-	-	■	■	■	■	-	-	-		
		12	-	G1, G1 1/4, G1 1/2, G2	-	-	-	■	■	■	-	-	-		
Pressure regulators MS-LRB		4	G1/4	G1/8, G1/4, G3/8	-	-	■	■	■	-	-	-	-		
		6	G1/2	G1/4, G3/8, G1/2, G3/4	-	-	■	■	■	■	-	-	-		
		9	-	-	-	-	-	-	-	-	-	-	-		
		12	-	-	-	-	-	-	-	-	-	-	-		
Precision pressure regulators MS-LRP		4	-	-	-	-	-	-	-	-	-	-	-		
		6	G1/4, G3/8, G1/2	G1/4, G3/8, G1/2, G3/4	■	■	■	-	■	-	-	-	-		
		9	-	-	-	-	-	-	-	-	-	-	-		
		12	-	-	-	-	-	-	-	-	-	-	-		
Precision pressure regulators MS-LRPB		4	-	-	-	-	-	-	-	-	-	-	-		
		6	G1/2	G1/4, G3/8, G1/2, G3/4	■	■	■	-	■	-	-	-	-		
		9	-	-	-	-	-	-	-	-	-	-	-		
		12	-	-	-	-	-	-	-	-	-	-	-		
Electrical pressure regulators MS-LRE		4	-	-	-	-	-	-	-	-	-	-	-		
		6	G1/4, G3/8, G1/2	G1/4, G3/8, G1/2, G3/4	-	-	■	■	■	■	-	-	-		
		9	-	-	-	-	-	-	-	-	-	-	-		
		12	-	-	-	-	-	-	-	-	-	-	-		
Lubricators MS-LOE		4	G1/8, G1/4	G1/8, G1/4, G3/8	-	-	-	-	-	-	-	-	-		
		6	G1/4, G3/8, G1/2	G1/4, G3/8, G1/2, G3/4	-	-	-	-	-	-	-	-	-		
		9	G3/4, G1	G1/2, G3/4, G1, G1 1/4, G1 1/2	-	-	-	-	-	-	-	-	-		
		12	-	G1, G1 1/4, G1 1/2, G2	-	-	-	-	-	-	-	-	-		
On-off valves, manually actuated MS-EM(1)		4	G1/8, G1/4	G1/8, G1/4, G3/8	-	-	-	-	-	-	-	-	-		
		6	G1/4, G3/8, G1/2	G1/4, G3/8, G1/2, G3/4	-	-	-	-	-	-	-	-	-		
		9	G3/4, G1	G1/2, G3/4, G1, G1 1/4, G1 1/2	-	-	-	-	-	-	-	-	-		
		12	-	G1, G1 1/4, G1 1/2, G2	-	-	-	-	-	-	-	-	-		
On-off valves, electrically actuated MS-EE		4	G1/8, G1/4	G1/8, G1/4, G3/8	-	-	-	-	-	■	-	■	■		
		6	G1/4, G3/8, G1/2	G1/4, G3/8, G1/2, G3/4	-	-	-	-	-	■	-	■	■		
		9	G3/4, G1	G1/2, G3/4, G1, G1 1/4, G1 1/2	-	-	-	-	-	■	■	■	■		
		12	-	G1, G1 1/4, G1 1/2, G2	-	-	-	-	-	■	■	■	■		
Soft-start valves, pneumatically actuated MS-DL		4	G1/8, G1/4	G1/8, G1/4, G3/8	-	-	-	-	-	-	-	-	-		
		6	G1/4, G3/8, G1/2	G1/4, G3/8, G1/2, G3/4	-	-	-	-	-	-	-	-	-		
		9	-	-	-	-	-	-	-	-	-	-	-		
		12	-	G1, G1 1/4, G1 1/2, G2	-	-	-	-	-	-	-	-	-		
Soft-start valves, electrically actuated MS-DE		4	G1/8, G1/4	G1/8, G1/4, G3/8	-	-	-	-	-	■	-	■	■		
		6	G1/4, G3/8, G1/2	G1/4, G3/8, G1/2, G3/4	-	-	-	-	-	■	-	■	■		
		9	-	-	-	-	-	-	-	-	-	-	-		
		12	-	G1, G1 1/4, G1 1/2, G2	-	-	-	-	-	■	■	■	■		

Branching modules/Distributor blocks MS-FRM, MS series

Product range overview – MS series service units

Type	Size	Bowl guard		Pressure indicator				Security			Options		→ Page/ Internet
		Plastic bowl with plastic bowl guard	Metal bowl	Cover plate (without pressure gauge)	Integrated MS pressure gauge	Adapter plate for EN pressure gauge G1/8	Adapter plate for EN pressure gauge G1/4	Pressure sensor	Rotary knob with detent, lockable via accessories	Rotary knob with integrated lock	Silencer	Flow direction from right to left	
Code		R	U	VS	AG	A8	A4	AD...	AS	E11	S	Z	
Individual devices													
Pressure regulators MS-LR	4	-	-	■	■	■	■	■	■	■	-	■	ms4-lr
	6	-	-	■	■	-	■	■	■	■	-	■	ms6-lr
	9	-	-	■	■	-	■	■	■	■	-	■	ms9-lr
	12	-	-	■	■	-	■	-	■	■	-	■	ms12-lr
Pressure regulators MS-LRB	4	-	-	■	■	■	■	■	■	■	-	■	ms4-lrb
	6	-	-	■	■	-	■	■	■	■	-	■	ms6-lrb
	9	-	-	-	-	-	-	-	-	-	-	-	-
	12	-	-	-	-	-	-	-	-	-	-	-	-
Precision pressure regulators MS-LRP	4	-	-	-	-	-	-	-	-	-	-	-	-
	6	-	-	■	-	■	■	■	■	■	-	■	ms6-lrp
	9	-	-	-	-	-	-	-	-	-	-	-	-
	12	-	-	-	-	-	-	-	-	-	-	-	-
Precision pressure regulators MS-LRPB	4	-	-	-	-	-	-	-	-	-	-	-	-
	6	-	-	■	-	■	■	■	■	■	-	■	ms6-lrpb
	9	-	-	-	-	-	-	-	-	-	-	-	-
	12	-	-	-	-	-	-	-	-	-	-	-	-
Electrical pressure regulators MS-LRE	4	-	-	-	-	-	-	-	-	-	-	-	-
	6	-	-	■	■	-	■	-	-	-	-	■	ms6-lre
	9	-	-	-	-	-	-	-	-	-	-	-	-
	12	-	-	-	-	-	-	-	-	-	-	-	-
Lubricators MS-LOE	4	■	■	-	-	-	-	-	-	-	-	■	ms4-loe
	6	■	■	-	-	-	-	-	-	-	-	■	ms6-loe
	9	-	■	-	-	-	-	-	-	-	-	■	ms9-loe
	12	-	■	-	-	-	-	-	-	-	-	■	ms12-loe
On-off valves, manually actuated MS-EM(1)	4	-	-	■	■	■	■	■	-	-	■	■	ms4-em1
	6	-	-	■	■	-	■	■	-	-	■	■	ms6-em1
	9	-	-	■	■	-	■	-	-	-	■	■	ms9-em
	12	-	-	■	■	-	■	-	-	-	■	■	ms12-em
On-off valves, electrically actuated MS-EE	4	-	-	■	■	■	■	■	-	-	■	■	ms4-ee
	6	-	-	■	■	-	■	■	-	-	■	■	ms6-ee
	9	-	-	■	■	-	■	■	-	-	■	■	ms9-ee
	12	-	-	■	■	-	■	-	-	-	■	■	ms12-ee
Soft-start valves, pneumatically actuated MS-DL	4	-	-	■	■	■	■	■	-	-	-	■	ms4-dl
	6	-	-	■	■	-	■	■	-	-	-	■	ms6-dl
	9	-	-	-	-	-	-	-	-	-	-	-	-
	12	-	-	■	■	-	■	-	-	-	-	■	ms12-dl
Soft-start valves, electrically actuated MS-DE	4	-	-	■	■	■	■	■	-	-	-	■	ms4-de
	6	-	-	■	■	-	■	■	-	-	-	■	ms6-de
	9	-	-	-	-	-	-	-	-	-	-	-	-
	12	-	-	■	■	-	■	-	-	-	-	■	ms12-de

Branching modules/Distributor blocks MS-FRM, MS series



Product range overview – MS series service units

Type	Size	Pneumatic connection in housing	Connecting plate	Performance Level			Supply voltage					
				Category 1, 1-channel	Category 3, 2-channel	Category 4, 2-channel with self-monitoring	24 V DC, Sub-D, 9-pin	24 V DC, connection pattern to EN 175301	24 V DC, connection M12 to IEC61076-2-101	110/230 V AC, connection pattern to EN 175301	22 ... 31.6 V DC, connection M12, AS-i Safety at Work	
Code			AG.../AQ...	C	D	E	10V24	10V24/ V24	10V24P	V110/ V230	ASIS	
Individual devices												
Soft start and exhaust valves MS-SV-C		4	–									
		6	G1/2	G1/4, G3/8, G1/2, G3/4	■	–	–	–	■	■	–	–
		9	G3/4, G1	G1/2, G3/4, G1, G1 1/4, G1 1/2	■	–	–	–	■	■	■	–
		12	–									
Soft start and exhaust valves MS-SV-D		4	–									
		6	G1/2	G1/4, G3/8, G1/2, G3/4	–	■	–	–	■	■	–	–
		9	–									
		12	–									
Soft start and exhaust valves MS-SV-E		4	–									
		6	G1/2	G1/4, G3/8, G1/2, G3/4	–	–	■	■	–	–	–	■
		9	–									
		12	–									
Membrane air dryers MS-LDM1		4	G1/8, G1/4	G1/8, G1/4, G3/8	–	–	–	–	–	–	–	–
		6	G1/4, G3/8, G1/2	G1/4, G3/8, G1/2, G3/4	–	–	–	–	–	–	–	–
		9	–									
		12	–									
Branching modules MS-FRM		4	G1/8, G1/4	G1/8, G1/4, G3/8	–	–	–	–	–	–	–	–
		6	G1/4, G3/8, G1/2	G1/4, G3/8, G1/2, G3/4	–	–	–	–	–	–	–	–
		9	G3/4, G1	G1/2, G3/4, G1, G1 1/4, G1 1/2	–	–	–	–	–	–	–	–
		12	–	G1, G1 1/4, G1 1/2, G2	–	–	–	–	–	–	–	–
Distributor blocks MS-FRM-FRZ		4	G1/4	–	–	–	–	–	–	–	–	–
		6	G1/2	–	–	–	–	–	–	–	–	–
		9	–									
		12	–									
Flow sensors SFAM		4	–									
		6	G1/2	G1/2	–	–	–	–	–	–	–	–
		9	–	G1, G1 1/2	–	–	–	–	–	–	–	–
		12	–									

Branching modules/Distributor blocks MS-FRM, MS series

Product range overview – MS series service units

Type	Size	Bowl guard		Pressure indicator					Switch output		Options		→ Page/ Internet
		Plastic bowl with plastic bowl guard	Metal bowl	Cover plate (without pressure gauge)	Integrated MS pressure gauge	Adapter plate for EN pressure gauge G ³ / ₈	Adapter plate for EN pressure gauge G ¹ / ₄	Pressure sensor	2x PNP or NPN, 1 analogue output 4 ... 20 mA	2x PNP or NPN, 1 analogue output 0 ... 10 V	Silencer	Flow direction from right to left	
Code		R	U	VS	AG	A8	A4	AD...	2SA	2SV	S	Z/R	
Individual devices													
Soft start and exhaust valves MS-SV-C	4	-	-	-	-	-	-	-	-	-	-	-	-
	6	-	-	■	■	-	■	■	-	-	■	■	ms6-sv
	9	-	-	■	■	-	■	■	-	-	■	■	ms9-sv
	12	-	-	-	-	-	-	-	-	-	-	-	-
Soft start and exhaust valves MS-SV-D	4	-	-	-	-	-	-	-	-	-	-	-	-
	6	-	-	■	■	-	■	■	-	-	■	■	ms6-sv
	9	-	-	-	-	-	-	-	-	-	-	-	-
Soft start and exhaust valves MS-SV-E	4	-	-	-	-	-	-	-	-	-	-	-	-
	6	-	-	■	■	-	■	■	-	-	■	■	ms6-sv
	9	-	-	-	-	-	-	-	-	-	-	-	-
Membrane air dryers MS-LDM1	4	-	■	-	-	-	-	-	-	-	-	■	ms4-ldm1
	6	-	■	-	-	-	-	-	-	-	-	■	ms6-ldm1
	9	-	-	-	-	-	-	-	-	-	-	-	-
	12	-	-	-	-	-	-	-	-	-	-	-	-
Branching modules MS-FRM	4	-	-	■	■	■	■	■	-	-	-	■	8
	6	-	-	■	■	-	■	■	-	-	-	■	8
	9	-	-	■	■	-	■	■	-	-	-	■	20
	12	-	-	■	-	-	-	-	-	-	-	-	30
Distributor blocks MS-FRM-FRZ	4	-	-	-	-	-	-	-	-	-	-	■	18
	6	-	-	-	-	-	-	-	-	-	-	■	18
	9	-	-	-	-	-	-	-	-	-	-	-	-
	12	-	-	-	-	-	-	-	-	-	-	-	-
Flow sensors SFAM	4	-	-	-	-	-	-	-	-	-	-	-	-
	6	-	-	-	-	-	-	-	■	■	-	■	sfam-62
	9	-	-	-	-	-	-	-	■	■	-	■	sfam-90
	12	-	-	-	-	-	-	-	-	-	-	-	-

Branching modules MS4/MS6-FRM, MS series

Peripherals overview

Branching module MS4/MS6-FRM

 Note
 Additional accessories:
 – Module connector for combination with size MS4/MS6 or size MS9 → Internet: amv, rmv, armv
 – Adapter plate for mounting on profiles → Internet: ipm-80, ipm-40-80, ipm-80-80

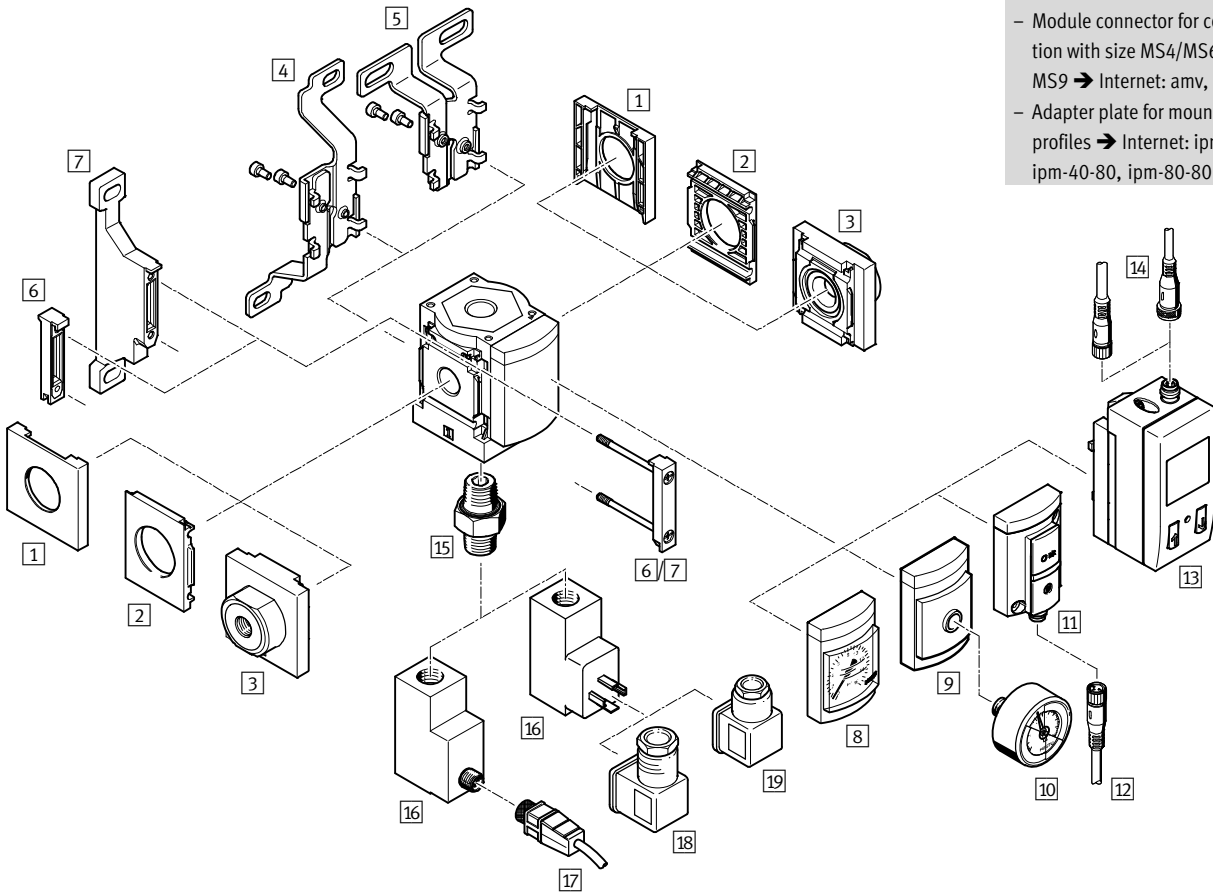

Branching modules MS4/MS6-FRM, MS series

Peripherals overview

Mounting attachments and accessories						
		Individual device		Combination		→ Page/Internet
		Without connecting plate	With connecting plate	Without connecting plate	With connecting plate	
1	Cover cap MS4/6-END	■	-	■	-	ms4-end, ms6-end
2	Mounting plate MS4/6-AEND	■ ¹⁾	-	■ ¹⁾	-	ms4-aend, ms6-aend
3	Connecting plate-SET MS4/6-AG...	-	■ ¹⁾	-	■ ¹⁾	ms4-ag, ms6-ag
4	Mounting bracket MS4/6-WB	■	■	-	-	ms4-wb, ms6-wb
5	Mounting bracket MS4-WBM	■	■	-	-	ms4-wbm
6	Module connector MS4/6-MV	-	■	■	■	ms4-mv, ms6-mv
7	Mounting bracket MS4/6-WP	■	■	■	■	ms4-wp, ms6-wp
	Mounting bracket (not illustrated) MS4/6-WPB/WPE/WPM	■	■	■	■	ms4-wp, ms6-wp
8	MS pressure gauge AG	■	■	■	■	16
9	Adapter plate for EN pressure gauge 1/8/1/4 A8/A4	■	■	■	■	16
10	Pressure gauge MA	■	■	■	■	35
11	Pressure sensor without display AD7 ... AD10	■	■	■	■	16
12	Connecting cable NEBU-M8...-LE3	■	■	■	■	35
13	Pressure sensor with display AD1 ... AD4	■	■	■	■	16
14	Connecting cable NEBU-M8...-LE3/NEBU-M12...-LE4	■	■	■	■	35
15	Double nipple ESK	■	■	■	■	36
16	Pressure switch PEV X/Y/M12	■	■	■	■	16
17	Connecting cable NEBU-M12...-LE4	■	■	■	■	35
18	Angled socket PEV-1/4-WD-LED...	■	■	■	■	36
19	Plug socket MSSD-C-4P	■	■	■	■	36

1) Module connector MS4/6-MV [6] or mounting bracket MS4/6-WP/WPB/WPE/WPM [7] is required for mounting.

Branching modules MS4/MS6-FRM, MS series

Type codes

MS 4 - FRM - 1/4 - Y

Series

MS	Standard service unit
----	-----------------------

Size

4	Grid dimension 40 mm
6	Grid dimension 62 mm

Service function

FRM	Branching module
-----	------------------

Pneumatic connection

MS4	
1/8	Female thread G1/8
1/4	Female thread G1/4
MS6	
1/4	Female thread G1/4
3/8	Female thread G3/8
1/2	Female thread G1/2

Non-return function/pressure switch

	Standard
I	With integrated non-return function
Y	With pressure switch

Further variants can be ordered using the modular system → 16

- Connecting plates
- Pressure gauge/pressure gauge alternatives
- Alternative pressure gauge scale
- Pressure switch
- Type of mounting
- EU certification
- UL certification
- Flow direction

Branching modules MS4/MS6-FRM, MS series

Technical data

Function
Standard

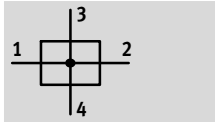

With integrated non-return function

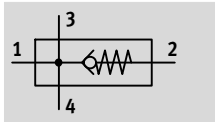

-  Flow rate
1,200 ... 14,700 l/min

-  Temperature range
-10 ... +60 °C

-  Operating pressure
0 ... 20 bar



- Pneumatic manifold with 4 connections
- Can be used as an intermediate distributor for varying air qualities
- Attachment facility for auxiliary modules
- Outlet top and bottom
- An integrated non-return valve prevents the return flow e.g. of lubricated compressed air
- Optional pressure sensor
- Optional device variant EX4 for use in potentially explosive areas in zones 1, 2, 21 and 22

General technical data		
Size	MS4	MS6
Pneumatic connection 1, 2	Female thread	G $\frac{1}{8}$ or G $\frac{1}{4}$
	Connecting plate AG...	G $\frac{1}{8}$, G $\frac{1}{4}$ or G $\frac{3}{8}$
Pneumatic connection 3, 4	G $\frac{1}{4}$	G $\frac{1}{2}$
Design	Branching module	
	Branching module with non-return function	
Type of mounting	Via accessories	
	In-line installation	
Assembly position	Any ¹⁾	
Pressure display	Via pressure sensor for displaying output pressure via LCD display and electrical output	
	Via pressure sensor for displaying output pressure via operational status indicator and electrical output	
	Via pressure gauge for displaying output pressure	
	Via pressure gauge with red/green scale for displaying output pressure	
	G $\frac{1}{4}$ prepared	
	G $\frac{1}{8}$ prepared	-

1) The branching module must be mounted vertically when combined with a pressure sensor as condensate must not collect in the pressure sensor.
-  Note: This product conforms to ISO 1179-1 and to ISO 228-1

Standard nominal flow rate qnN ¹⁾ [l/min]					
Size	MS4		MS6		
	G $\frac{1}{8}$	G $\frac{1}{4}$	G $\frac{1}{4}$	G $\frac{3}{8}$	G $\frac{1}{2}$
Standard					
In main flow direction 1 \rightarrow 2	1,800	4,600	4,200	9,200	14,700
Outlet at top	1,600	1,500	6,000	4,700	4,400
Outlet at bottom	1,700	1,500	6,400	4,800	4,600
With non-return function					
In main flow direction 1 \rightarrow 2	1,200	1,750	3,200	5,500	6,000
Outlet at top	500	500	2,700	2,900	3,100
Outlet at bottom	500	500	2,800	3,200	3,300

1) Measured at p₁ = 6 bar and p₂ = 5 bar, Δp = 1 bar

Branching modules MS4/MS6-FRM, MS series

Technical data

Operating and environmental conditions						
Size	MS4			MS6		
Variant	Standard	Non-return function I	Pressure switch X/Y/M12	Standard	Non-return function I	Pressure switch X/Y/M12
Operating pressure [bar]	0 ... 14 (0 ... 10) ¹⁾	0 ... 10	0 ... 12 (0 ... 10) ¹⁾	0 ... 20 (0 ... 10) ¹⁾	0 ... 20 (0 ... 10) ¹⁾	0 ... 12 (0 ... 10) ¹⁾
Operating medium	Compressed air in accordance with ISO 8573-1:2010 [7:4:4] Inert gases					
Note on operating/pilot medium	Operation with lubricated medium possible (in which case lubricated operation will always be required)					
Ambient temperature [°C]	-10 ... +60 (0 ... +50) ²⁾					
Temperature of medium [°C]	-10 ... +60 (0 ... +50) ²⁾					
Storage temperature [°C]	-10 ... +60					
Corrosion resistance class CRC ³⁾	2					
UL certification	cULus recognized (OL)					

1) Value in brackets applies to MS4/MS6-FRM with pressure sensor AD... or with UL certification.

2) Value in brackets applies to MS4/MS6-FRM with pressure sensor AD... .

3) Corrosion resistance class CRC 2 to Festo standard FN 940070

Moderate corrosion stress. Indoor applications in which condensation may occur. External visible parts with primarily decorative requirements for the surface and which are in direct contact with the ambient atmosphere typical for industrial applications.

ATEX	
EU certification	EX4
ATEX category gas	II 2G
Ex-ignition protection type gas	c T6 X
ATEX category dust	II 2D
EX-ignition protection type dust	c 60 °C X
ATEX ambient temperature	-10 °C ≤ Ta ≤ +60 °C
CE mark (see declaration of conformity)	To EU Explosion Protection Directive (ATEX)

Weight [g]		
Size	MS4	MS6
Branching module	165	458
Branching module with non-return function I	160	400
Branching module with pressure sensor AD...	255	528
Branching module with pressure switch X/Y/M12	405	736

Materials

Sectional view

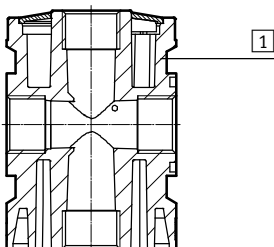

Branching module	
1) Housing	Die-cast aluminium
Note on materials	RoHS-compliant Free of copper and PTFE (not with variants AG or AD...)

Branching modules MS4/MS6-FRM, MS series

Technical data

Dimensions – Basic version

Download CAD data → www.festo.com

With female thread, with cover plate



Type	B1	B2	B3	D1	D2	L1	L2	L3
MS4-FRM-1/8	40	21	54	G1/8	G1/4	60.4	27	58
MS4-FRM-1/4				G1/4				
MS6-FRM-1/4	62	31	76	G1/4	G1/2	87.2	39	84.5
MS6-FRM-3/8				G3/8				
MS6-FRM-1/2				G1/2				

Note: This product conforms to ISO 1179-1 and to ISO 228-1

Dimensions – Pressure gauge/pressure gauge alternatives

Download CAD data → www.festo.com

Integrated MS pressure gauge with standard scale AG or red-green scale RG, display unit [bar]

Adapter plate A8/A4 for EN pressure gauge 1/8/1/4, without pressure gauge

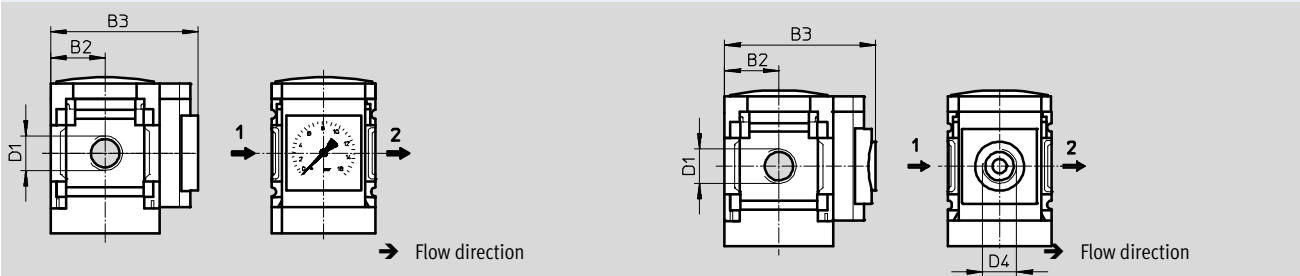

Type	B2	B3		D1	D4
		Standard	With integrated non-return function I		
MS4-FRM-1/8-...-AG	21	65		G1/8	-
MS4-FRM-1/4-...-AG				G1/4	
MS4-FRM-1/8-...-RG	21	66.5		G1/8	-
MS4-FRM-1/4-...-RG				G1/4	
MS4-FRM-1/8-...-A8	21	58.5		G1/8	G1/8
MS4-FRM-1/4-...-A8				G1/4	
MS4-FRM-1/8-...-A4	21	58.5		G1/8	G1/4
MS4-FRM-1/4-...-A4				G1/4	
MS6-FRM-1/4-...-AG	31	77		G1/4	-
MS6-FRM-3/8-...-AG				G3/8	
MS6-FRM-1/2-...-AG				G1/2	
MS6-FRM-1/4-...-RG	31	78.5		G1/4	-
MS6-FRM-3/8-...-RG				G3/8	
MS6-FRM-1/2-...-RG				G1/2	
MS6-FRM-1/4-...-A4	31	78.5		G1/4	G1/4
MS6-FRM-3/8-...-A4				G3/8	
MS6-FRM-1/2-...-A4				G1/2	

Note: This product conforms to ISO 1179-1 and to ISO 228-1

Branching modules MS4/MS6-FRM, MS series

Technical data

Dimensions – Pressure gauge/pressure gauge alternatives Download CAD data → www.festo.com
 Pressure sensor with LCD display AD1 ... AD4 Technical data → Internet: sde1

Variant AD1:
SDE1-D10-G2-MS-L-P1-M8 with 3-pin plug M8x1, 1 switch output PNP

Variant AD2:
SDE1-D10-G2-MS-L-N1-M8 with 3-pin plug M8x1, 1 switch output NPN

Variant AD3:
SDE1-D10-G2-MS-L-PI-M12 with 4-pin plug M12x1, 1 switch output PNP and 4 ... 20 mA analogue

Variant AD4:
SDE1-D10-G2-MS-L-NI-M12 with 4-pin plug M12x1, 1 switch output NPN and 4 ... 20 mA analogue

→ Flow direction

Pressure sensor with operational status indicator AD7 ... AD10 Technical data → Internet: sde5

Variant AD7:
SDE5-D10-O-...-P-M8 with 3-pin plug M8x1, threshold value comparator, 1 switching output PNP, N/O contact

Variant AD8:
SDE5-D10-C-...-P-M8 with 3-pin plug M8x1, threshold value comparator, 1 switching output PNP, N/C contact

Variant AD9:
SDE5-D10-O3-...-P-M8 with 3-pin plug M8x1, window comparator, 1 switching output PNP, N/O contact

Variant AD10:
SDE5-D10-C3-...-P-M8 with 3-pin plug M8x1, window comparator, 1 switching output PNP, N/C contact

→ Flow direction

Type	B2	B3	D1	D6	L5	L6
MS4-FRM-1/8-...-AD1/AD2	21	82.6	G1/8	M8x1	35.1	46.7
MS4-FRM-1/4-...-AD1/AD2			G1/4			
MS4-FRM-1/8-...-AD3/AD4	21	82.6	G1/8	M12x1	35.1	55.8
MS4-FRM-1/4-...-AD3/AD4			G1/4			
MS4-FRM-1/8-...-AD7/AD8/AD9/AD10	21	59	G1/8	M8x1	-	-
MS4-FRM-1/4-...-AD7/AD8/AD9/AD10			G1/4			
MS6-FRM-1/4-...-AD1/AD2	31	103	G1/4	M8x1	35.1	46.7
MS6-FRM-3/8-...-AD1/AD2			G3/8			
MS6-FRM-1/2-...-AD1/AD2			G1/2			
MS6-FRM-1/4-...-AD3/AD4	31	103	G1/4	M12x1	35.1	55.8
MS6-FRM-3/8-...-AD3/AD4			G3/8			
MS6-FRM-1/2-...-AD3/AD4			G1/2			
MS6-FRM-1/4-...-AD7/AD8/AD9/AD10	31	79	G1/4	M8x1	-	-
MS6-FRM-3/8-...-AD7/AD8/AD9/AD10			G3/8			
MS6-FRM-1/2-...-AD7/AD8/AD9/AD10			G1/2			

• Note: This product conforms to ISO 1179-1 and to ISO 228-1

Branching modules MS4/MS6-FRM, MS series

Technical data

Dimensions – Pressure switch Download CAD data → www.festo.com
 Pressure switch with adjustable pressure switching point X/Y/M12 Technical data → Internet: pev-1/4

Variant X:
PEV-1/4-SC-0D with display, plug, square design to EN 175 301, type A

Variant Y:
PEV-1/4-B-0D, plug, square design to EN 175 301, type A

Variant M12:
PEV-1/4-B-M12 with 4-pin plug M12x1

Type	B1	B2	B4	D1	L1
MS4-FRM-...-X/Y	40	21	63	–	92.3
MS4-FRM-...-M12	40	21	61	M12x1	92.3
MS6-FRM-...-X/Y	62	31	73	–	99.5
MS6-FRM-...-M12	62	31	71	M12x1	99.5

★ Core product range

Ordering data			
Size	Connection	Part No.	Type
MS6	G1/4	★ 529857	MS6-FRM-1/4
	G1/2	★ 529853	MS6-FRM-1/2

Ordering data			
Size	Connection	Part No.	Type
MS4	G1/8	529559	MS4-FRM-1/8
	G1/4	529555	MS4-FRM-1/4
MS6	G3/8	529861	MS6-FRM-3/8
With integrated non-return function			
MS4	G1/4	536966	MS4-FRM-1/4-I
MS6	G1/4	536967	MS6-FRM-1/4-I
	G1/2	536969	MS6-FRM-1/2-I
With pressure switch PEV-1/4-B-0D (variant Y)			
MS4	G1/4	529556	MS4-FRM-1/4-Y
MS6	G1/4	529858	MS6-FRM-1/4-Y
	G3/8	529862	MS6-FRM-3/8-Y
	G1/2	529854	MS6-FRM-1/2-Y

Festo core product range ★ Ready for dispatch from the Festo factory in 24 hours
 ☆ Ready for dispatch in 5 days maximum from stock

Branching modules MS4/MS6-FRM, MS series

Ordering data – Modular products

M Mandatory data →

Module No.	Series	Size	Function	Pneumatic connection
527703 527676	MS	4 6	FRM	1/8, 1/4, 3/8, 1/2, AG...
Order example				
527676	MS	6	- FRM	- 3/8

Ordering table						
Grid dimension	[mm]	40	62	Conditions	Code	Enter code
M Module No.		527703	527676			
Series		Standard			MS	MS
Size		4	6		...	
Function		Branching module			-FRM	-FRM
Pneumatic connection		Female thread G1/8	-	<input type="checkbox"/>	-1/8	
		Female thread G1/4	Female thread G1/4	<input type="checkbox"/>	-1/4	
		-	Female thread G3/8	<input type="checkbox"/>	-3/8	
		-	Female thread G1/2	<input type="checkbox"/>	-1/2	
		Connecting plate G1/8	-		-AGA	
		Connecting plate G1/4	Connecting plate G1/4		-AGB	
		Connecting plate G3/8	Connecting plate G3/8		-AGC	
		-	Connecting plate G1/2		-AGD	
	-	Connecting plate G3/4		-AGE		

1/8, 1/4, 3/8, 1/2, AD1 ... AD4, AD7 ... AD10, X, Y, M12, WPM
Not with EU certification EX4

Transfer order code

	MS		- FRM		
--	-----------	--	--------------	--	--

Branching modules MS4/MS6-FRM, MS series

Ordering data – Modular products

Options							
Auxiliary function	Pressure gauge/ pressure gauge alternatives	Alternative pressure gauge scale	Pressure switch	Type of mounting	EU certification	UL certification	Flow direction
I	AG, A8, A4, RG, AD1 ... AD4, AD7 ... AD10	PSI, MPA	X, Y, M12	WP, WPM, WB, WBM	EX4	UL1	Z
-	- AG	-	-	-	-	-	-

Ordering table							
Grid dimension	[mm]	40	62	Conditions	Code	Enter code	
0	Auxiliary function	With integrated non-return function				-I	
	Pressure gauge/pressure gauge alternatives	MS pressure gauge, bar				-AG	
		Adapter plate for EN pressure gauge 1/8, without pressure gauge			-	-A8	
		Adapter plate for EN pressure gauge 1/4, without pressure gauge				-A4	
		Integrated pressure gauge, red-green scale				-RG	
		Pressure sensor with LCD display, plug M8, 1 switching output PNP, 3-pin			1 2	-AD1	
		Pressure sensor with LCD display, plug M8, 1 switching output NPN, 3-pin			1 2	-AD2	
		Pressure sensor with LCD display, plug M12, 1 switching output PNP, 4-pin, analogue output 4 ... 20 mA			1 2	-AD3	
		Pressure sensor with LCD display, plug M12, 1 switching output NPN, 4-pin, analogue output 4 ... 20 mA			1 2	-AD4	
		Pressure sensor with operational status indicator, plug M8, threshold value comparator, PNP, N/O contact			1 2	-AD7	
		Pressure sensor with operational status indicator, plug M8, threshold value comparator, PNP, N/C contact			1 2	-AD8	
	Pressure sensor with operational status indicator, plug M8, window comparator, PNP, N/O contact			1 2	-AD9		
	Pressure sensor with operational status indicator, plug M8, window comparator, PNP, N/C contact			1 2	-AD10		
	Alternative pressure gauge scale	psi			3	-PSI	
		MPa			4	-MPA	
	Pressure switch	Pressure switch PEV with display, plug socket, EN 175301, type A, square			1 5	-X	
		Pressure switch PEV without display, plug socket, EN 175301, type A, square			1 5	-Y	
		Pressure switch PEV without display, plug socket, round, M12, 4-pin			1 5	-M12	
	Type of mounting	Mounting bracket standard design			6	-WP	
		Mounting bracket for attaching the service units			1 6	-WPM	
		Mounting bracket centrally at rear (wall mounting top and bottom), connecting plates not required				-WB	
		Mounting bracket centrally at rear (wall mounting top), connecting plates not required			-	-WBM	
	EU certification	II 2GD to EU Explosion Protection Directive (ATEX)				-EX4	
	UL certification	cULus, ordinary location for Canada and USA				-UL1	
	Flow direction	Flow direction from right to left				-Z	

2 AD1 ... AD4, AD7 ... AD10

Measuring range max. 10 bar

3 PSI

Only in combination with pressure gauge AG

4 MPA

Only in combination with pressure gauge AG or RG

5 X, Y, M12

Max. permissible operating pressure P1 = 12 bar.

6 WP, WPM

Only with connecting plate AGA, AGB, AGC, AGD or AGE

Transfer order code

- [] - [] - [] - [] - [] - [] - [] - []

Distributor blocks MS4/MS6-FRM-FRZ, MS series

Technical data

Function

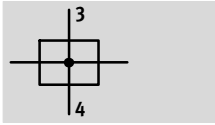

- - Flow rate
2,900 ... 14,600 l/min
- - Temperature range
-10 ... +60 °C
- - Operating pressure
0 ... 20 bar



- - Note
The distributor block MS4/6-FRM-FRZ has a half grid dimension width.

- Pneumatic manifold with 4 connections
- Outlet top and bottom
- Can be used as an intermediate distributor for varying air qualities
- Can be used as an intermediate distributor between two pressure regulators with large rotary knob with pressure gauge on size MS4

General technical data		
Size	MS4	MS6
Pneumatic connection 3, 4	G1/4	G1/2
Design	Branching module	
Type of mounting	Via accessories	
	In-line installation	
Assembly position	Any	

- - Note: This product conforms to ISO 1179-1 and to ISO 228-1

Standard nominal flow rate $q_{nN}^{1)}$ [l/min]		
Size	MS4	MS6
In main flow direction 1 \rightarrow 2	4,050	14,600
Outlet at top	3,250	10,400
Outlet at bottom	2,900	9,850

1) Measured at $p_1 = 6$ bar and $p_2 = 5$ bar, $\Delta p = 1$ bar

Operating and environmental conditions		
Size	MS4	MS6
Operating pressure [bar]	0 ... 14 (0 ... 10) ¹⁾	0 ... 20 (0 ... 10) ¹⁾
Operating medium	Compressed air in accordance with ISO 8573-1:2010 [7:4:4]	
	Inert gases	
Note on operating/pilot medium	Operation with lubricated medium possible (in which case lubricated operation will always be required)	
Ambient temperature [°C]	-10 ... +60	
Temperature of medium [°C]	-10 ... +60	
Storage temperature [°C]	-10 ... +60	
Corrosion resistance class CRC ²⁾	2	
UL certification	cULus recognized (OL)	

1) Value in brackets applies to MS4/MS6-FRM-FRZ with UL certification.

2) Corrosion resistance class CRC 2 to Festo standard FN 940070

Moderate corrosion stress. Indoor applications in which condensation may occur. External visible parts with primarily decorative requirements for the surface and which are in direct contact with the ambient atmosphere typical for industrial applications.

Distributor blocks MS4/MS6-FRM-FRZ, MS series

Technical data

Weight [g]		
Size	MS4	MS6
Distributor block	60	163

Materials

Sectional view

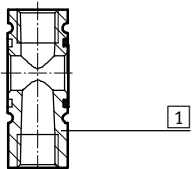

Distributor block	
1 Housing	Die-cast aluminium
Note on materials	RoHS-compliant
	Free of copper and PTFE

Dimensions

Download CAD data → www.festo.com

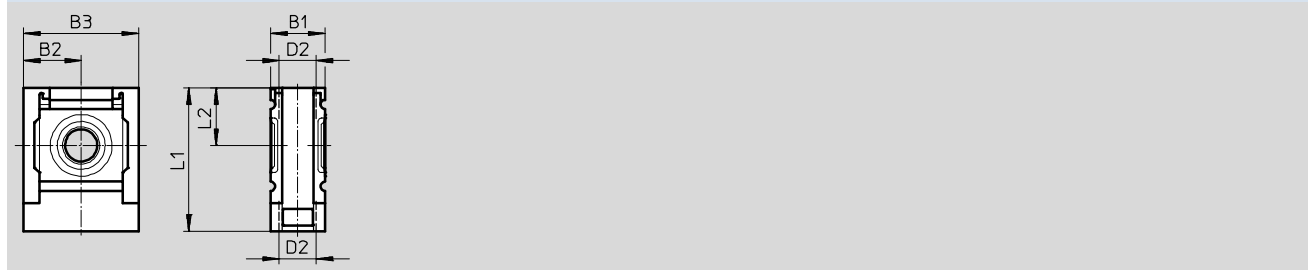

Type	B1	B2	B3	D2	L1	L2
MS4-FRM-FRZ	20	21	42	G $\frac{1}{4}$	52.5	21
MS6-FRM-FRZ	31	31	62	G $\frac{1}{2}$	76.5	31

• † - Note: This product conforms to ISO 1179-1 and to ISO 228-1

★ Core product range

Ordering data		
Size	Part No.	Type
MS4	★ 549336	MS4-FRM-FRZ
MS6	★ 549337	MS6-FRM-FRZ

Festo core product range

- ★ Ready for dispatch from the Festo factory in 24 hours
- ☆ Ready for dispatch in 5 days maximum from stock

Branching modules MS9-FRM, MS series

Peripherals overview

FESTO

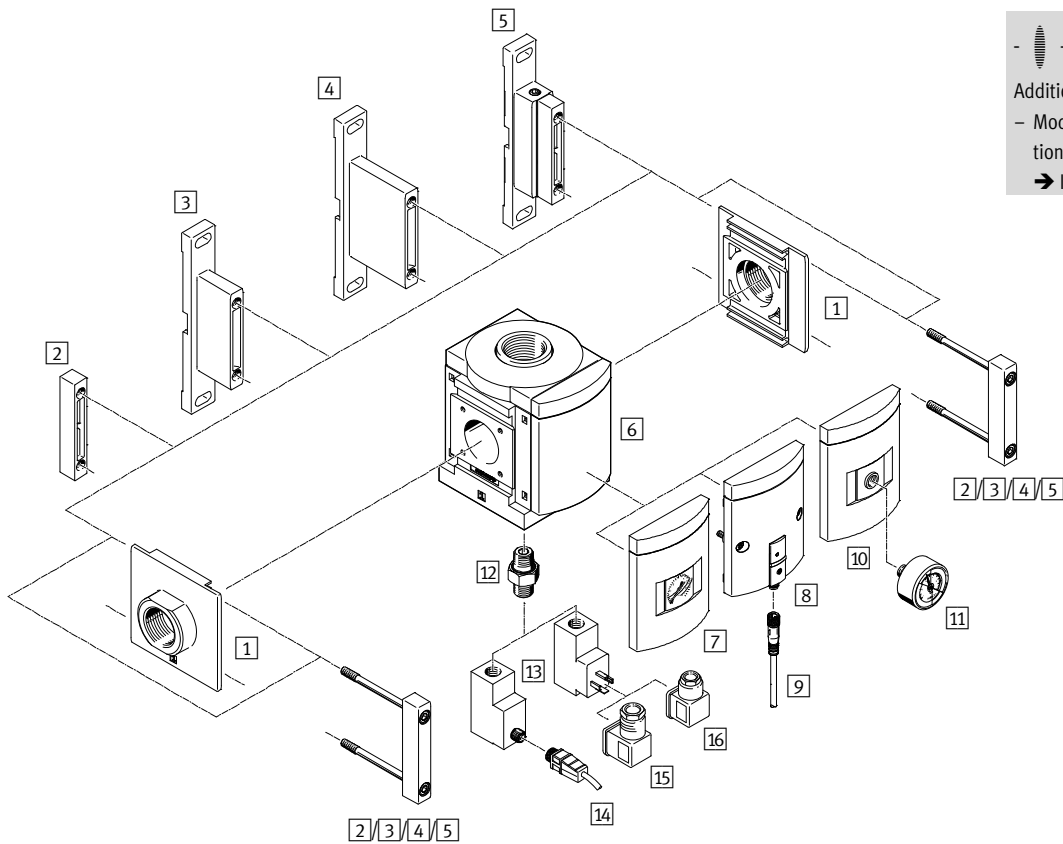

Note
Additional accessories:
– Module connector for combination with size MS6, MS9 or MS12
→ Internet: rmv, armv

Branching modules MS9-FRM, MS series

Peripherals overview

Mounting attachments and accessories					
		Individual component		Combination	→ Page/ Internet
		With female thread 3/4/1/N3/4/N1	With connecting plate AG.../AQ...		
			Without EU certification EX4	With EU certification EX4	
1	Connecting plate-SET MS9-AG...	-	■	■	ms9-ag
	Connecting plate-SET MS9-AQ...	-	■	-	ms9-aq
2	Module connector MS9-MV	-	-	-	ms9-mv
3	Mounting bracket MS9-WP	■	■	■	ms9-wp
4	Mounting bracket MS9-WPB	■	■	■	ms9-wp
5	Mounting bracket MS9-WPM	■	■	-	ms9-wp
6	Cover plate VS	■	■	■	28
7	MS pressure gauge AG	■	■	■	28
8	Pressure sensor without display AD7 ... AD10	■	■	-	28
9	Connecting cable NEBU-M8...-LE3	■	■	-	35
10	Adapter plate for EN pressure gauge 1/4 A4	■	■	■	28
11	Pressure gauge MA	■	■	■	35
12	Double nipple (included in the scope of delivery) ESK	■	■	-	-
13	Pressure switch PEV X/Y/M12	■	■	-	28
14	Connecting cable NEBU-M12...-LE4	■	■	-	35
15	Angled socket PEV-1/4-WD-LED-...	■	■	-	36
16	Plug socket MSSD-C-4P	■	■	-	36

Branching modules MS9-FRM, MS series

Type codes

FESTO

MS		9	-	FRM	-	G	-	VS	-	Y
Series										
MS	Standard service unit									
Size										
9	Grid dimension 90 mm									
Service function										
FRM	Branching module									
Pneumatic connection										
G	Module without connecting thread, without connecting plate									
NG	Module without connecting thread, without connecting plate (pneumatic connections 3 and 4 in NPT)									
Pressure gauge alternatives										
VS	Cover plate									
Pressure switch										
	Without pressure switch									
Y	With pressure switch									

Additional variants can be ordered using the modular system → 28

- Pneumatic connection
- Pressure gauge/pressure gauge alternatives
- Alternative pressure gauge scale
- Pressure switch
- Type of mounting
- EU certification
- UL certification
- Flow direction

Branching modules MS9-FRM, MS series

Technical data

Function

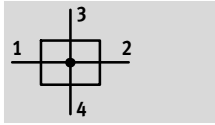

- - Flow rate
10,000 ... 50,000 l/min
- - Temperature range
-10 ... +60 °C
- - Operating pressure
0 ... 20 bar



- Pneumatic manifold with 4 connections
- Attachment facility for auxiliary modules
- Outlet at top and bottom
- Can be used as an intermediate distributor for varying air qualities
- Optional device variant EX4 for use in potentially explosive areas in zones 1, 2, 21 and 22
- Optional pressure sensor

General technical data	
Pneumatic connection 1, 2	
Female thread	G $\frac{3}{4}$, G1, NPT $\frac{3}{4}$ or NPT1
Connecting plate AG...	G $\frac{1}{2}$, G $\frac{3}{4}$, G1, G1 $\frac{1}{4}$ or G1 $\frac{1}{2}$
Connecting plate AQ...	NPT $\frac{1}{2}$, NPT $\frac{3}{4}$, NPT1, NPT1 $\frac{1}{4}$ or NPT1 $\frac{1}{2}$
Module without connecting thread/plate G/NG	-
Pneumatic connection 3, 4	G1 (pneumatic connection 1, 2: $\frac{3}{4}$ /1/AG.../G) NPT1-1 $\frac{1}{2}$ (pneumatic connection 1, 2: N $\frac{3}{4}$ /N1/AQ.../NG)
Design	Branching module
Type of mounting	Via accessories In-line installation Front panel mounting
Mounting position	Any ¹⁾
Pressure display	Via pressure sensor for displaying output pressure via operational status indicator and electrical output Via pressure gauge for displaying output pressure Via pressure gauge with red/green scale for displaying output pressure G $\frac{1}{4}$ prepared

1) The branching module must be mounted vertically when combined with a pressure sensor as condensate must not collect in the pressure sensor.
- | - Note: This product conforms to ISO 1179-1 and to ISO 228-1

Standard nominal flow rate q _{nN} ¹⁾ [l/min]					
Pneumatic connection	Connecting plate AGD/AQR	Female thread G $\frac{3}{4}$ /NPT $\frac{3}{4}$, connecting plate AGE/AQS	Female thread G1/NPT1, connecting plate AGF/AQT	Connecting plate AGG/AQU	Connecting plate AGH/AQV
In main flow direction 1 → 2	10,000	25,000	45,000	47,000	50,000
Outlet at top	13,000				
Outlet at bottom	13,000				

1) Measured at p₁ = 6 bar and p₂ = 5 bar, Δp = 1 bar

Branching modules MS9-FRM, MS series

Technical data

Operating and environmental conditions			
Variant	Standard	Pressure switch X/Y/M12	Pressure sensor AD...
Operating pressure [bar]	0 ... 20	0 ... 12	0 ... 10
Operating medium	Compressed air in accordance with ISO 8573-1:2010 [7:4:4]		
Note on operating/pilot medium	Operation with lubricated medium possible		
Ambient temperature [°C]	-10 ... +60	-10 ... +60	0 ... +50
Temperature of medium [°C]	-10 ... +60	-10 ... +60	0 ... +50
Storage temperature [°C]	-10 ... +60	-10 ... +60	-10 ... +60
Corrosion resistance class CRC ¹⁾	2		
Certification (variant UL1)	cULus recognized (OL)		

1) Corrosion resistance class CRC 2 to Festo standard FN 940070
Moderate corrosion stress. Indoor applications in which condensation may occur. External visible parts with primarily decorative requirements for the surface and which are in direct contact with the ambient atmosphere typical for industrial applications.

ATEX	
EU certification	EX4
ATEX category gas	II 2G
Ex-ignition protection type gas	c T6 X
ATEX category dust	II 2D
EX-ignition protection type dust	c 60 °C X
ATEX ambient temperature	-10 °C ≤ Ta ≤ +60 °C
CE mark (see declaration of conformity)	To EU Explosion Protection Directive (ATEX)

Weight [g]	
Branching module	1,000
Branching module with pressure switch X/Y/M12	1,100

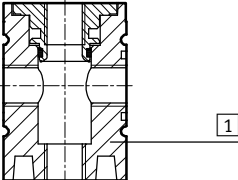
Materials												
Sectional view												
	Branching module											
	<table border="1"> <tbody> <tr> <td>1</td> <td>Housing</td> <td>Die-cast aluminium</td> </tr> <tr> <td>-</td> <td>Cover</td> <td>PA reinforced</td> </tr> <tr> <td>-</td> <td>Connecting plate, module connector, mounting bracket</td> <td>Die-cast aluminium</td> </tr> <tr> <td colspan="2">Note on materials</td> <td>RoHS-compliant Free of copper and PTFE (not with variant AG)</td> </tr> </tbody> </table>	1	Housing	Die-cast aluminium	-	Cover	PA reinforced	-	Connecting plate, module connector, mounting bracket	Die-cast aluminium	Note on materials	
1	Housing	Die-cast aluminium										
-	Cover	PA reinforced										
-	Connecting plate, module connector, mounting bracket	Die-cast aluminium										
Note on materials		RoHS-compliant Free of copper and PTFE (not with variant AG)										

Branching modules MS9-FRM, MS series

Technical data

Dimensions – Basic version

Download CAD data → www.festo.com

Module without connecting thread, without connecting plate G/NG, with cover plate VS



Type	B1	B2	B3	L1	L2
MS9-FRM-G/NG	90	45	109	122	64

Dimensions – Connecting thread/connecting plate

Download CAD data → www.festo.com

With female thread 3/4/1/N3/4/N1

With connecting plate AG.../AQ...

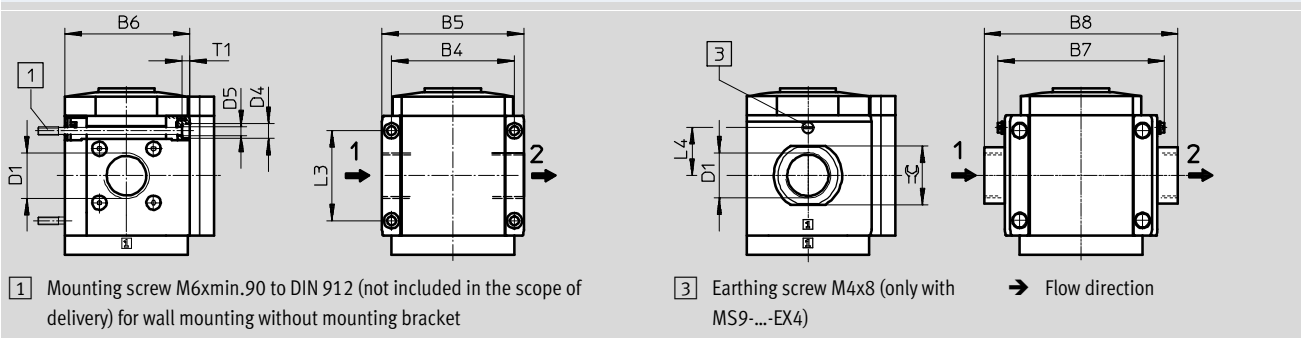

Type	B4	B5	B6	B7		B8	D1	D4	D5	L3	L4		T1	≙
					EX4						EX4	EX4		
MS9-FRM-3/4	90	104	91.5	-	-	-	G3/4	11	6.5	66	-	-	6	-
MS9-FRM-1							G1							
MS9-FRM-AGD	-	-	-	112	122	-	132	-	-	-	35	-	-	30
MS9-FRM-AGE							G3/4							36
MS9-FRM-AGF							G1							41
MS9-FRM-AGG							G1 1/4							50
MS9-FRM-AGH							G1 1/2							55
MS9-FRM-N3/4	90	104	91.5	-	-	-	NPT3/4-14	11	6.5	66	-	-	6	-
MS9-FRM-N1							NPT1-11 1/2							
MS9-FRM-AQR	-	-	-	112	-	-	132	-	-	-	-	-	-	30
MS9-FRM-AQS							NPT3/4-14							36
MS9-FRM-AQT							NPT1-11 1/2							41
MS9-FRM-AQU							NPT1 1/4-11 1/2							50
MS9-FRM-AQV							NPT1 1/2-11 1/2							55

- | - Note: This product conforms to ISO 1179-1 and to ISO 228-1

Branching modules MS9-FRM, MS series

Technical data

FESTO

Dimensions – Pressure gauge/pressure gauge alternatives

Download CAD data → www.festo.com

Integrated MS pressure gauge with standard scale AG or red/green scale RG

Adapter plate A4 for EN pressure gauge 1/4, without pressure gauge

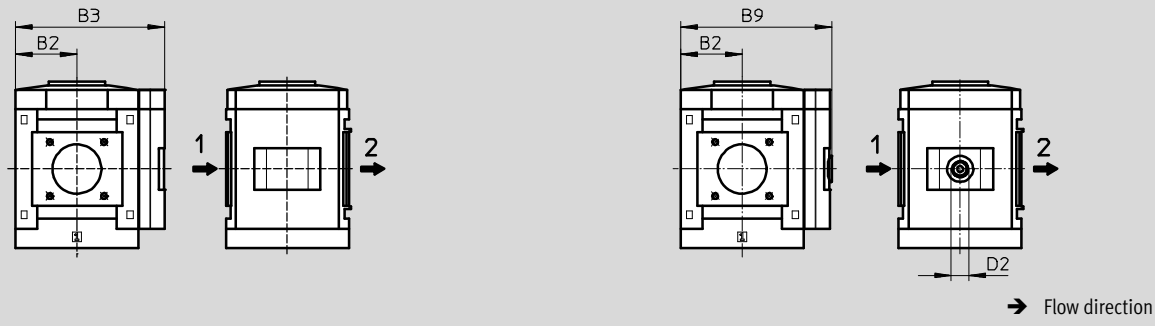

Type	B2	B3	B9	D2
MS9-FRM-...-AG/RG	45	109	-	-
MS9-FRM-...-A4		-	110	G1/4

• Note: This product conforms to ISO 1179-1 and to ISO 228-1

Dimensions – Pressure gauge/pressure gauge alternatives

Download CAD data → www.festo.com

Pressure sensor with operational status indicator AD7 ... AD10

Technical data → Internet: sde5

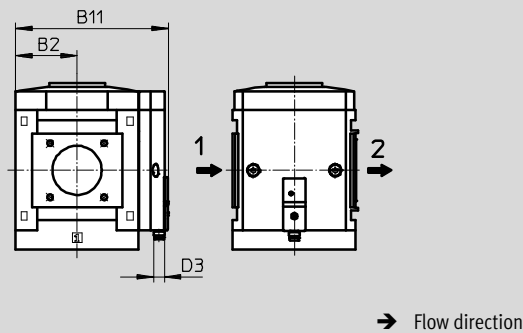

Variant AD7:
SDE5-D10-0-...-P-M8 with 3-pin plug M8x1, threshold value comparator, 1 switching output PNP, N/O contact

Variant AD9:
SDE5-D10-03-...-P-M8 with 3-pin plug M8x1, window comparator, 1 switching output PNP, N/O contact

Variant AD8:
SDE5-D10-C-...-P-M8 with 3-pin plug M8x1, threshold value comparator, 1 switching output PNP, N/C contact

Variant AD10:
SDE5-D10-C3-...-P-M8 with 3-pin plug M8x1, window comparator, 1 switching output PNP, N/C contact

Type	B2	B11	D3
MS9-FRM-...-AD7/AD8/AD9/AD10	45	112	M8

Branching modules MS9-FRM, MS series

Technical data

Dimensions – Pressure switch Download CAD data → www.festo.com
 Pressure switch with adjustable pressure switching point X/Y/M12 Technical data → Internet: pev-1/4

Variant X: PEV-1/4-SC-OD with display, plug, square design to EN 175 301, type A
 Variant Y: PEV-1/4-B-OD, plug, square design to EN 175 301, type A
 Variant M12: PEV-1/4-B-M12 with 4-pin plug M12x1

Type	B1	B2	B4	D1	L1
MS9-FRM-...-X/Y	90	45	87	–	105
MS9-FRM-...-M12	90	45	85	M12x1	105

Ordering data					
Size	Standard		With pressure switch PEV-1/4-B-OD (variant Y)		
	Part No.	Type	Part No.	Type	
Cover plate					
MS9	564145	MS9-FRM-G-VS	564147	MS9-FRM-G-VS-Y	
Pneumatic connections 3 and 4 in NPT, cover plate					
MS9	564148	MS9-FRM-NG-VS	564150	MS9-FRM-NG-VS-Y	

Branching modules MS9-FRM, MS series

Ordering data – Modular products

M Mandatory data →

Module No.	Series	Size	Function	Pneumatic connection
562534	MS	9	FRM	¾, 1, AG..., N¾, N1, AQ..., G, NG
Ordering example				
562534	MS	9	- FRM	- AGE

Ordering table

Grid dimension	[mm]	90	Condi- tions	Code	Enter code
M Module No.	562534				
Series	Standard			MS	MS
Size	9			9	9
Function	Branching module			-FRM	-FRM
Pneumatic connection	Female thread G¾		1	-¾	
	Female thread G1		1	-1	
	Connecting plate G½			-AGD	
	Connecting plate G¾			-AGE	
	Connecting plate G1			-AGF	
	Connecting plate G1¼			-AGG	
	Connecting plate G1½			-AGH	
	Female thread NPT¾		1	-N¾	
	Female thread NPT1		1	-N1	
	Connecting plate NPT½		1	-AQR	
	Connecting plate NPT¾		1	-AQS	
	Connecting plate NPT1		1	-AQT	
	Connecting plate NPT1¼		1	-AQU	
	Connecting plate NPT1½		1	-AQV	
	Module without connecting thread, without connecting plate		1	-G	
	Module without connecting thread, without connecting plate (pneumatic connections 3 and 4 in NPT)		1	-NG	

1 ¾, 1, N¾, N1, AQR, AQS, AQT, AQU, AQV, G, NG, AD7, AD8, AD9, AD10, X, Y, M12, WPM

Not with EU certification EX4

Transfer order code

562534	MS	9	-	FRM	-	
--------	----	---	---	-----	---	--

Branching modules MS9-FRM, MS series

Ordering data – Modular products

→ M		Options				
Pressure gauge/ pressure gauge alternatives	Alternative pressure gauge scale	Pressure switch	Type of mounting	EU certification	UL certification	Flow direction
AG, VS, A4, RG, AD7 ... AD10	PSI, MPA, BAR	X, Y, M12	WP, WPM, WPB	EX4	UL1	Z
- VS	-	-	-	-	-	-

Ordering table		Grid dimension [mm]	90	Condi- tions	Code	Enter code
M	Pressure gauge/pressure gauge alternatives	MS pressure gauge			-AG	
		Cover plate			-VS	
		Adapter plate for EN pressure gauge 1/4, without pressure gauge			-A4	
		Integrated pressure gauge, red/green scale		2	-RG	
		Pressure sensor with operational status indicator, plug M8, threshold value comparator, PNP, N/O contact		1 3	-AD7	
		Pressure sensor with operational status indicator, plug M8, threshold value comparator, PNP, N/C contact		1 3	-AD8	
		Pressure sensor with operational status indicator, plug M8, window comparator, PNP, N/O contact		1 3	-AD9	
		Pressure sensor with operational status indicator, plug M8, window comparator, PNP, N/C contact		1 3	-AD10	
O	Alternative pressure gauge scale	psi		4	-PSI	
		MPa		4	-MPA	
		bar		4	-BAR	
	Pressure switch	Pressure switch PEV with display, plug socket, EN175301, type A, cube		1 5	-X	
		Pressure switch PEV without display, plug socket, EN 175301, type A, cube		1 5	-Y	
		Pressure switch PEV without display, plug socket, round, M12, 4-pin		1 5	-M12	
	Type of mounting	Mounting bracket standard design		6	-WP	
		Mounting bracket for attaching the service units		1 6	-WPM	
		Mounting bracket for large wall gap		6	-WPB	
	EU certification	II 2GD to EU Explosion Protection Directive (ATEX)			-EX4	
	UL certification	cULus, ordinary location for Canada and USA			-UL1	
	Flow direction	Flow direction from right to left			-Z	

1 3/4, 1, N3/4, N1, AQR, AQS, AQT, AQU, AQV, G, NG, AD7, AD8, AD9, AD10, X, Y, M12, **WPM**

5 X, Y, M12

Max. permissible operating pressure P1 = 12 bar

6 WP, WPM, WPB

Not with pneumatic connection G/NG

2 RG Not with EU certification EX4

3 AD7 ... AD10 Not with alternative pressure gauge scale PSI, PSI scale serves only as an auxiliary scale

4 PSI, MPA, BAR Measuring range max. 10 bar

Not with pressure gauge alternatives VS, A4, AD7, AD8, AD9, AD10

Transfer order code

- [] - [] - [] - [] - [] - [] - []

Branching modules MS12-FRM, MS series

Peripherals overview

Branching modules MS12-FRM

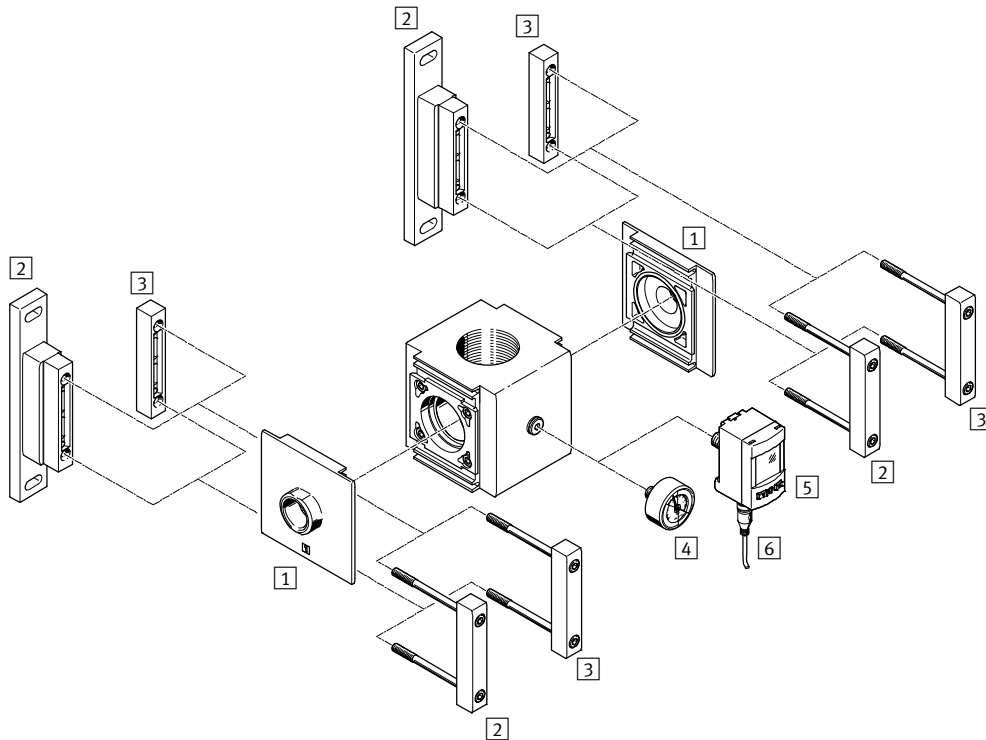

-  - Note
 Additional accessories:
 - Module connector for combination with size MS9 → Internet: armv

Mounting attachments and accessories		→ Page/Internet
1	Connecting plate-SET MS12-AG...	ms12-ag
2	Mounting bracket MS12-WP	ms12-wp
3	Module connector MS12-MV	ms12-mv
4	Pressure gauge MA	35
5	Pressure sensor SPAU	35
6	Connecting cable NEBU-M8...-LE4/NEBU-M12...-LE4	35

Branching modules MS12-FRM, MS series

Type codes

		MS	12	-	FRM	-	G
Series							
MS	Standard service unit						
Size							
12	Grid dimension 124 mm						
Service function							
FRM	Branching module						
Connection size							
G	Module without connecting thread, without connecting plate Connecting plates → Accessories						

Further variants can be ordered using the modular system → 34

- Connecting plates
- Type of mounting



Branching modules MS12-FRM, MS series

Technical data

FESTO

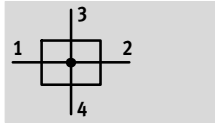
Function



-  - Flow rate
25,000 ... 42,000 l/min
-  - Temperature range
-10 ... +60 °C
-  - Operating pressure
0 ... 20 bar



- Pneumatic manifold with 4 connections
- Attachment facility for auxiliary modules
- Outlet top and bottom
- Can be used as an intermediate distributor for varying air qualities

General technical data	
Pneumatic connection 1, 2	
Connecting plate AG...	G1, G1¼, G1½ or G2
Module without connecting thread/plate G	-
Pneumatic connection 3	G2
Pneumatic connection 4	G1
Design	Branching module
Type of mounting	Via accessories
	In-line installation
Assembly position	Any

• Note: This product conforms to ISO 1179-1 and to ISO 228-1

Standard nominal flow rate q_{nN}^1 [l/min]	
In main flow direction 1 → 2	25,000 ... 42,000

1) Dependent on connecting plate AG... selected
Measured at $p_1 = 6$ bar and $p_2 = 5$ bar, $\Delta p = 1$ bar

Operating and environmental conditions		
Operating pressure	[bar]	0 ... 20
Operating medium		Compressed air in accordance with ISO 8573-1:2010 [-:--:-]
Ambient temperature	[°C]	-10 ... +60
Temperature of medium	[°C]	-10 ... +60
Storage temperature	[°C]	-10 ... +60
Corrosion resistance	CRC ¹⁾	2

1) Corrosion resistance class CRC 2 to Festo standard FN 940070
Moderate corrosion stress. Indoor applications in which condensation may occur. External visible parts with primarily decorative requirements for the surface and which are in direct contact with the ambient atmosphere typical for industrial applications.

Branching modules MS12-FRM, MS series

Technical data

Weights [g]	
Branching module	3,000

Materials

Sectional view

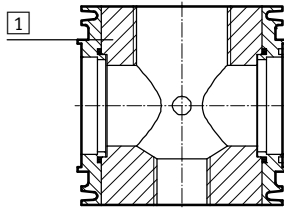

Branching module		
1	Body	Die-cast aluminium
-	Seals	NBR
-	Connecting plate, module connector, mounting bracket	Die-cast aluminium
Note on materials		Free of copper and PTFE

Dimensions – Basic version

Download CAD data → www.festo.com

Without connecting thread G

1 G $\frac{1}{4}$ Female thread in body, sealed with cover plate by default

→ Flow direction

Type	B1	B2	B3	D2	D3	D4	L1	L2
MS12-FRM-G	124	124	134	G2	G1	G $\frac{1}{4}$	122	61

• Note: This product conforms to ISO 1179-1 and to ISO 228-1

Ordering data		
Size	Part No.	Type
MS12	541681	MS12-FRM-G

Branching modules MS12-FRM, MS series

Ordering data – Modular products

M Mandatory data				O Options		
Module No.	Series	Size	Function	Pneumatic connection	Type of mounting	
535035	MS	12	FRM	AG..., G	WP	
Order example						
535035	MS	12	- FRM	- AGF	- WP	

Ordering table					
Grid dimension	[mm]	124	Condi- tions	Code	Enter code
M	Module No.	535035			
	Series	Standard		MS	MS
	Size	12		12	12
	Function	Branching module		-FRM	-FRM
	Pneumatic connection	Connecting plate G1		-AGF	
		Connecting plate G1¼		-AGG	
		Connecting plate G1½		-AGH	
		Connecting plate G2		-AGI	
		Module without connecting thread, without connecting plate		-G	
O	Type of mounting	Mounting bracket standard design	1	-WP	

1 WP Only with connecting plate AGF, AGG, AGH or AGI.

Transfer order code

535035	MS	12	- FRM	-	-	-
--------	----	----	-------	---	---	---



Branching modules/distributor blocks MS-FRM, MS series



FESTO

Accessories

Ordering data – Pressure gauge MA							Technical data → Internet: ma	
	Nominal size	Pneumatic connection	Display range		Part No.	Type		
			[bar]	[psi]				
	Pressure gauge MA, EN 837-1							
	40	R $\frac{1}{4}$	0 ... 16	0 ... 232	187080	MA-40-16-R $\frac{1}{4}$ -EN		
		G $\frac{1}{4}$	0 ... 16	0 ... 232	183901	MA-40-16-G $\frac{1}{4}$ -EN		
	Pressure gauge MA, EN 837-1, with red-green range							
40	R $\frac{1}{8}$	0 ... 16	–	525726	MA-40-16-R $\frac{1}{8}$ -E-RG			
50	R $\frac{1}{4}$	0 ... 16	–	525729	MA-50-16-R $\frac{1}{4}$ -E-RG			

Ordering data – Pressure sensor SPAU						Technical data → Internet: spau		
	Pneumatic connection	Switching output	Display type	Electrical connection	Part No.	Type		
Pressure sensor SPAU for direct mounting on the service unit with pressure gauge connection (adapter for pneumatic connection included in scope of delivery), pressure measuring range 0 ... 10 bar, relative pressure measurement								
	Male thread R $\frac{1}{8}$	2x PNP or 2x NPN, switch- able	Illuminated LCD	M8x1, 4-pin	8001203	SPAU-P10R-T-R18M-L-PNLK-PNVBA-M8D		
				M12x1, 4-pin	8001206	SPAU-P10R-T-R18M-L-PNLK-PNVBA-M12D		
	Male thread R $\frac{1}{4}$			M8x1, 4-pin	8001209	SPAU-P10R-T-R14M-L-PNLK-PNVBA-M8D		
				M12x1, 4-pin	8001208	SPAU-P10R-T-R14M-L-PNLK-PNVBA-M12D		

Ordering data – Connecting cable NEBU-M8					Technical data → Internet: nebu		
	Electrical connection	Number of wires	Cable length [m]	Part No.	Type		
	M8x1, straight socket	3	2.5	★ 541333	NEBU-M8G3-K-2.5-LE3		
			5	★ 541334	NEBU-M8G3-K-5-LE3		
		4	2.5	541342	NEBU-M8G4-K-2.5-LE4		
			5	541343	NEBU-M8G4-K-5-LE4		
	M8x1, angled socket	3	2.5	★ 541338	NEBU-M8W3-K-2.5-LE3		
			5	★ 541341	NEBU-M8W3-K-5-LE3		
		4	2.5	541344	NEBU-M8W4-K-2.5-LE4		
			5	541345	NEBU-M8W4-K-5-LE4		

Ordering data – Connecting cable NEBU-M12					Technical data → Internet: nebu		
	Electrical connection	Number of wires	Cable length [m]	Part No.	Type		
	M12x1, straight socket	3	2.5	★ 541363	NEBU-M12G5-K-2.5-LE3		
			5	★ 541364	NEBU-M12G5-K-5-LE3		
		4	2.5	★ 550326	NEBU-M12G5-K-2.5-LE4		
			5	★ 541328	NEBU-M12G5-K-5-LE4		
	M12x1, angled socket	3	2.5	541367	NEBU-M12W5-K-2.5-LE3		
			5	541370	NEBU-M12W5-K-5-LE3		
		4	2.5	550325	NEBU-M12W5-K-2.5-LE4		
			5	541329	NEBU-M12W5-K-5-LE4		

Festo core product range

- ★ Ready for dispatch from the Festo factory in 24 hours
- ☆ Ready for dispatch in 5 days maximum from stock

Branching modules/distributor blocks MS-FRM, MS series

FESTO

Accessories

Ordering data – Angled socket PEV					Technical data → Internet: pev-1/4	
	Description	Operating voltage range	Electrical connection	Switching status display	Part No.	Type
	For PEV-1/4-...-OD	15 ... 30 V DC	4-pin	Yellow LED	164274	PEV-1/4-WD-LED-24
		≤ 230 V AC ≤ 180 V DC	4-pin	Yellow LED	164275	PEV-1/4-WD-LED-230

Ordering data – Plug socket MSSD					Technical data → Internet: mssd-c-4p	
	Description	Operating voltage range	Electrical connection	Type of mounting: cable connection	Part No.	Type
	For PEV-1/4-...-OD	≤ 250 V AC/DC	3-pin	Clamping screws	171157	MSSD-C-4P

Ordering data – Double nipple ESK					
	Description	Pneumatic connection		Part No.	Type
	For retrofitting pressure switch PEV to branching module MS-FRM	R1/4	R1/4	151521	ESK-1/4-1/4
			R1/2	534153	ESK-1/4-1/2

Festo North America

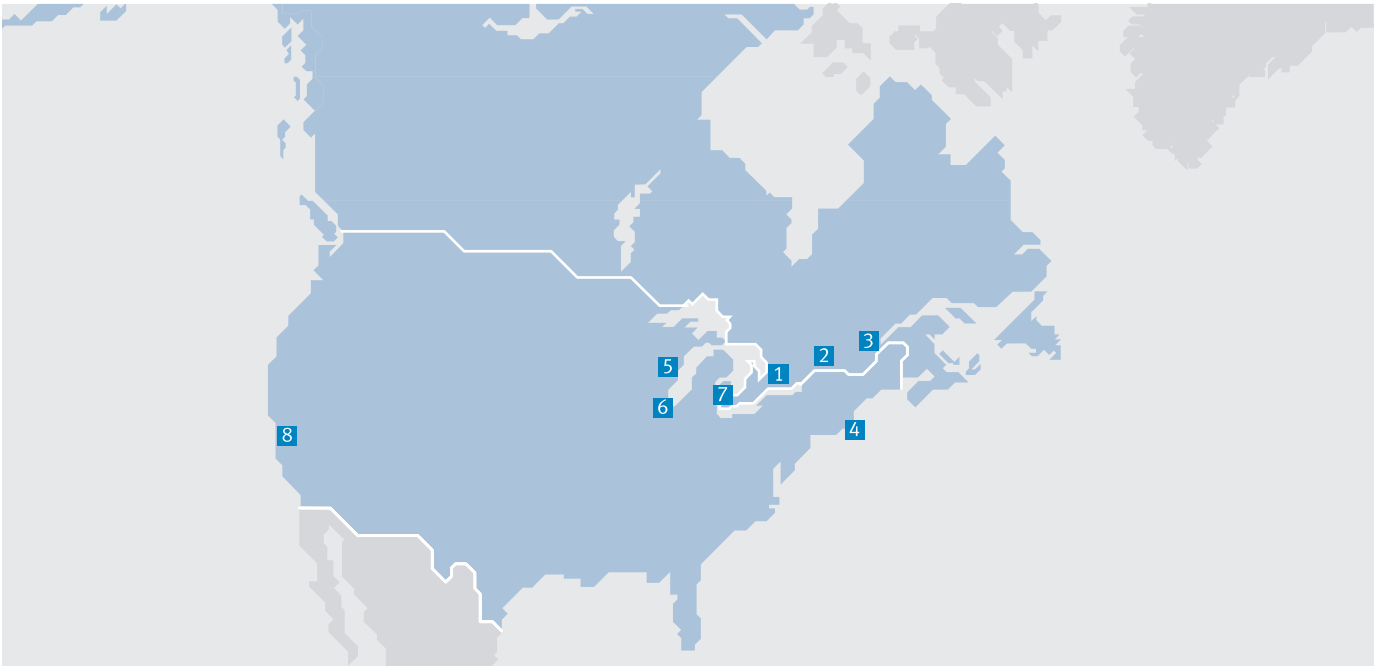

**1 Festo Canada
Headquarters
Festo Inc.**
5300 Explorer Drive
Mississauga, ON
L4W 5G4

2 Montréal
5600, Trans-Canada
Pointe-Claire, QC
H9R 1B6

3 Québec City
2930, rue Watt#117
Québec, QC
G1X 4G3



**4 Festo United States
Headquarters
Festo Corporation**
395 Moreland Road
Hauppauge, NY
11788

5 Appleton
North 922 Tower View Drive, Suite N
Greenville, WI
54942

7 Detroit
1441 West Long Lake Road
Troy, MI
48098

6 Chicago
85 W Algonquin - Suite 340
Arlington Heights, IL
60005

8 Silicon Valley
4935 Southfront Road, Suite F
Livermore, CA
94550

Festo Regional Contact Center

Canadian Customers

Commercial Support:
Tel: 1 877 GO FESTO (1 877 463 3786)
Fax: 1 877 FX FESTO (1 877 393 3786)
Email: festo.canada@ca.festo.com

Technical Support:
Tel: 1 866 GO FESTO (1 866 463 3786)
Fax: 1 877 FX FESTO (1 877 393 3786)
Email: technical.support@ca.festo.com

USA Customers

Commercial Support:
Tel: 1 800 99 FESTO (1 800 993 3786)
Fax: 1 800 96 FESTO (1 800 963 3786)
Email: customer.service@us.festo.com

Technical Support:
Tel: 1 866 GO FESTO (1 866 463 3786)
Fax: 1 800 96 FESTO (1 800 963 3786)
Email: product.support@us.festo.com

Subject to change

Internet: www.festo.com/us